

Teil-Nr.		Abmessungen				
Standard "S"	Selbstsichernd "L"	Gewinde A Ø A Tol.- 3B	Gewinde B Ø B Tol.- 2A mod.	Flanken- scherfläche inch <sup>2</sup> (mm <sup>2</sup> )	C inch (mm)	C1 inch (mm)
KNH0832J		8-32	5/16-18	0,1517 (97,87)	0,31 (7,87)	
	KNHL0832J			0,0945 (60,97)		0,29 (7,37)
KNH1032J		10-32	3/8-16	0,1901 (122,7)	0,31 (7,87)	
	KNHL1032J			0,1156 (74,6)		0,31 (7,87)
KNH1024J		10-24	3/8-16	0,1901 (122,7)	0,31 (7,87)	
	KNHL1024J			0,1156 (74,6)		0,31 (7,87)
KNH428J		1/4-28	7/16-14	0,2842 (183,4)	0,37 (9,40)	
	KNHL428J			0,1970 (127,1)		0,33 (8,38)
KNH420J		1/4-20	7/16-14	0,2842 (183,4)	0,37 (9,40)	
	KNHL420J			0,1970 (127,1)		0,36 (9,14)
KNH524J		5/16-24	1/2-13	0,3588 (231,5)	0,43 (10,9)	
	KNHL524J			0,2608 (168,3)		0,34 (8,64)

Teil-Nr.	Einbaumaße				Handeinbau- werkzeug Teil-Nr.	Ausbaumaß	
	Ø D Kern-Ø inch (mm)	Ø E Senk-Ø inch +0,01 (mm)	Gewinde F			Bohrung	
			Ø F Tol. - UNC 2B	G min. inch (mm)		Ø inch (mm)	Tiefe inch (mm)
KNH0832J	0,272 (6,91)	0,323 (8,20)	5/16-18	0,37 (9,4)	THD0832L	7/32 (5,56)	1/8 (3,18)
KNHL0832J							
KNH1032J	0,332 (8,43)	0,385 (9,78)	3/8-16	0,37 (9,4)	THD1032L	9/32 (7,14)	1/8 (3,18)
KNHL1032J							
KNH1024J	0,332 (8,43)	0,385 (9,78)	3/8-16	0,37 (9,4)	THD1024L	9/32 (7,14)	1/8 (3,18)
KNHL1024J							
KNH428J	0,397 (10,08)	0,447 (11,35)	7/16-14	0,43 (10,9)	THD428L	11/32 (8,73)	3/16 (4,76)
KNHL428J							
KNH420J	0,397 (10,08)	0,447 (11,35)	7/16-14	0,43 (10,9)	THD420L	11/32 (8,73)	3/16 (4,76)
KNHL420J							
KNH524J	0,453 (11,51)	0,510 (12,95)	1/2-13	0,50 (12,7)	THD524L	13/32 (10,32)	3/16 (4,76)
KNHL524J							

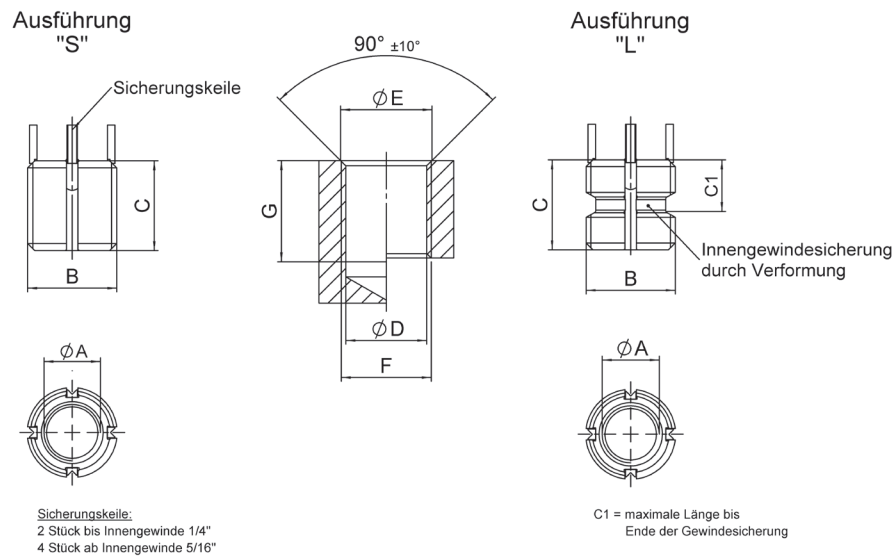

Teil-Nr.		Abmessungen				
Standard "S"	Selbstsichernd "L"	Gewinde A Ø A Tol.- 3B	Gewinde B Ø B Tol.- 2A mod.	Flanken- scherfläche inch <sup>2</sup> (mm <sup>2</sup> )	C inch (mm)	C1 inch (mm)
KNH518J		5/16-18	1/2-13	0,3588 (231,5)	0,43 (10,9)	
	KNHL518J			0,2608 (168,3)		0,37 (9,40)
KNH624J		3/8-24	9/16-12	0,4975 (321,0)	0,50 (12,7)	
	KNHL624J			0,3843 (248,0)		0,37 (9,40)
KNH616J		3/8-16	9/16-12	0,4975 (321,0)	0,50 (12,7)	
	KNHL616J			0,3843 (248,0)		0,41 (10,41)
KNH720J		7/16-20	5/8-11	0,7172 (462,7)	0,62 (15,8)	
	KNHL720J			0,5831 (376,2)		0,42 (10,67)
KNH714J		7/16-14	5/8-11	0,7172 (462,7)	0,62 (15,8)	
	KNHL714J			0,5831 (376,2)		0,46 (11,68)

Teil-Nr.	Einbaumaße				Handeinbau- werkzeug Teil-Nr.	Ausbaumaß	
	Ø D Kern-Ø inch (mm)	Ø E Senk-Ø inch +0,01 (mm)	Gewinde F			Bohrung	
			Ø F Tol.- UNC 2B	G min. inch (mm)		Ø inch (mm)	Tiefe inch (mm)
KNH518J	0,453 (11,51)	0,510 (12,95)	1/2-13	0,50 (12,7)	THD518L	13/32 (10,32)	3/16 (4,76)
KNHL518J							
KNH624J	0,516 (13,11)	0,572 (14,53)	9/16-12	0,56 (14,2)	THD624L	15/32 (11,91)	3/16 (4,76)
KNHL624J							
KNH616J	0,516 (13,11)	0,572 (14,53)	9/16-12	0,56 (14,2)	THD616L	15/32 (11,91)	3/16 (4,76)
KNHL616J							
KNH720J	0,578 (14,68)	0,635 (16,13)	5/8-11	0,68 (17,27)	THD720L	17/32 (13,49)	3/16 (4,76)
KNHL720J							
KNH714J	0,578 (14,68)	0,635 (16,13)	5/8-11	0,68 (17,27)	THD714L	17/32 (13,49)	3/16 (4,76)
KNHL714J							

Ausführung  
"S"

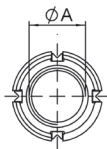
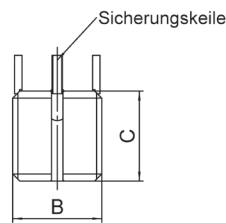

Sicherungskeile:  
2 Stück bis Innengewinde 1/4"  
4 Stück ab Innengewinde 5/16"

Ausführung  
"L"

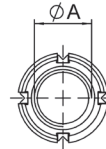
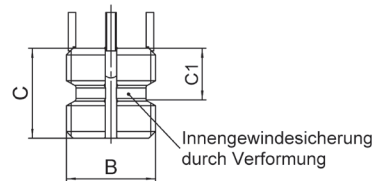

C1 = maximale Länge bis  
Ende der Gewindesicherung

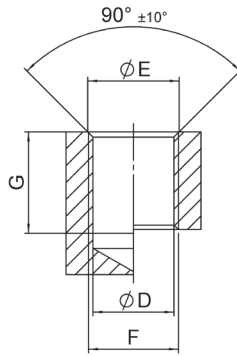

Teil-Nr.		Abmessungen				
Standard "S"	Selbstsichernd "L"	Gewinde A Ø A Tol.- 3B	Gewinde B Ø B Tol.- 2A mod.	Flanken- scherfläche inch <sup>2</sup> (mm <sup>2</sup> )	C inch (mm)	C1 inch (mm)
KNH820J	KNHL820J	1/2-20	11/16-11NS	0,8884 (573,2)	0,68 (17,3)	0,42 (10,67)
				0,7368 (475,4)		
KNH813J	KNHL813J	1/2-13	11/16-11NS	0,8884 (573,2)	0,68 (17,3)	0,47 (11,94)
				0,7368 (475,4)		
KNH918J	KNHL918J	9/16-18	13/16-16	1,2493 (806,0)	0,81 (20,6)	0,48 (12,19)
				1,0247 (661,1)		
KNH912J	KNHL912J	9/16-12	13/16-16	1,2493 (806,0)	0,81 (20,6)	0,54 (13,72)
				1,0247 (661,1)		
KNH1018J	KNHL1018J	5/8-18	7/8-14	1,4866 (959,1)	0,87 (22,1)	0,49 (12,47)
				1,2415 (801,0)		
KNH1011J	KNHL1011J	5/8-11	7/8-14	1,4866 (959,1)	0,87 (22,1)	0,57 (14,48)
				1,2415 (801,0)		

Teil-Nr.	Einbaumaße				Handeinbau- werkzeug Teil-Nr.	Ausbaumaß	
	Ø D Kern-Ø inch (mm)	Ø E Senk-Ø inch +0,01 (mm)	Gewinde F			Bohrung	
			Ø F Tol. - UNC 2B	G min. inch (mm)		Ø inch (mm)	Tiefe inch (mm)
KNH820J	0,641 (16,28)	0,700 (17,80)	11/16-11NS	0,75 (19,06)	THD820L	19/32 (15,08)	3/16 (4,76)
KNHL820J							
KNH813J	0,641 (16,28)	0,700 (17,80)	11/16-11NS	0,75 (19,06)	THD813L	19/32 (15,08)	3/16 (4,76)
KNHL813J							
KNH918J	0,766 (19,46)	0,822 (20,88)	13/16-16UN	0,94 (23,88)	THD918L	23/32 (18,26)	3/16 (4,76)
KNHL918J							
KNH912J	0,766 (19,46)	0,822 (20,88)	13/16-16UN	0,94 (23,88)	THD912L	23/32 (18,26)	3/16 (4,76)
KNHL912J							
KNH1018J	0,828 (21,03)	0,885 (22,48)	7/8-14UNF	1,00 (25,40)	THD1018L	25/32 (19,84)	3/16 (4,76)
KNHL1018J							
KNH1011J	0,828 (21,03)	0,885 (22,48)	7/8-14 UNF	1,00 (25,40)	THD1011L	25/32 (19,84)	3/16 (4,76)
KNHL1011J							

Ausführung  
"S"

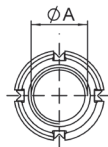
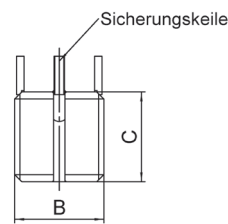

Sicherungskeile:  
2 Stück bis Innengewinde 1/4"  
4 Stück ab Innengewinde 5/16"

Ausführung  
"L"

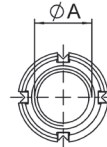
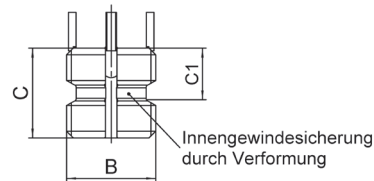

C1 = maximale Länge bis  
Ende der Gewindesicherung

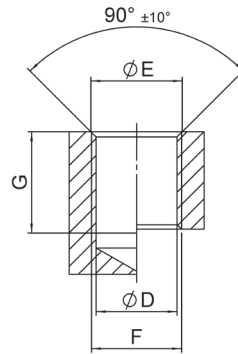

Teil-Nr.		Abmessungen				
Standard "S"	Selbstsichernd "L"	Gewinde A Ø A Tol.- 3B	Gewinde B Ø B Tol.- 2A mod.	Flanken- scherfläche inch² (mm²)	C inch (mm)	C1 inch (mm)
KNH1216J	KNHL1216J	3/4-16	1-1/8-12	2,4901 (1606,5)	1,12 (28,5)	0,68 (17,27)
				2,4478 (1579,3)	1,25 (31,8)	
KNH1210J	KNHL1210J	3/4-10	1-1/8-12	2,4901 (1606,5)	1,12 (28,5)	0,75 (19,05)
				2,4478 (1579,3)	1,25 (31,8)	
KNH1414J	KNHL1414J	7/8-14	1-1/4-12	3,1370 (2024,1)	1,25 (31,8)	0,69 (17,53)
				3,0775 (1985,6)	1,37 (34,8)	
KNH1409J	KNHL1409J	7/8-9	1-1/4-12	3,1370 (2024,1)	1,25 (31,8)	0,77 (19,56)
				3,0775 (1985,6)	1,37 (34,8)	
KNH1612J	KNHL1612J	1-12	1-3/8-12	3,8381 (2476,3)	1,37 (34,8)	0,78 (19,81)
				3,7929 (2447,0)	1,50 (38,1)	
KNH1608J	KNHL1608J	1-8	1-3/8-12	3,8381 (2476,3)	1,37 (34,8)	0,86 (21,84)
				3,7929 (2447,0)	1,50 (38,1)	

Teil-Nr.	Einbaumaße				Handeinbau- werkzeug Teil-Nr.	Ausbaumaß	
	Ø D Kern-Ø inch (mm)	Ø E Senk-Ø inch +0,01 (mm)	Gewinde F			Bohrung	
			Ø F Tol. - UNC 2B	G min. inch (mm)		Ø inch (mm)	Tiefe inch (mm)
KNH1216J	1,062 (26,97)	1,145 (29,08)	1-1/8-12 UNF	1,31 (33,27) 1,44 (36,58)	THD1216L	31/32 (24,61)	5/16 (7,94)
KNHL1216J							
KNH1210J	1,062 (26,97)	1,145 (29,08)	1-1/8-12 UNF	1,31 (33,27) 1,44 (36,58)	THD1210L	31/32 (24,61)	5/16 (7,94)
KNHL1210J							
KNH1414J	1,187 (30,15)	1,270 (32,26)	1-1/4-12 UNF	1,44 (36,58) 1,56 (39,62)	THD1414L	1-3/32 (27,78)	5/16 (7,94)
KNHL1414J							
KNH1409J	1,187 (30,15)	1,270 (32,26)	1-1/4-12 UNF	1,44 (36,58) 1,56 (39,62)	THD1409L	1-3/32 (27,78)	5/16 (7,94)
KNHL1409J							
KNH1612J	1,312 (33,32)	1,395 (35,43)	1-3/8-12 UNF	1,56 (39,62) 1,68 (42,67)	THD1612L	1-7/32 (30,96)	5/16 (7,94)
KNHL1612J							
KNH1608J	1,312 (33,32)	1,395 (35,43)	1-3/8-12 UNF	1,56 (39,62) 1,68 (42,67)	THD1608L	1-7/32 (30,96)	5/16 (7,94)
KNHL1608J							